

4-8 AÑOS



Centro de Referencia en Primeros Auxilios

PREVENCIÓN DE INCIDENTES

Colorear los lugares peligrosos dentro de cada escena

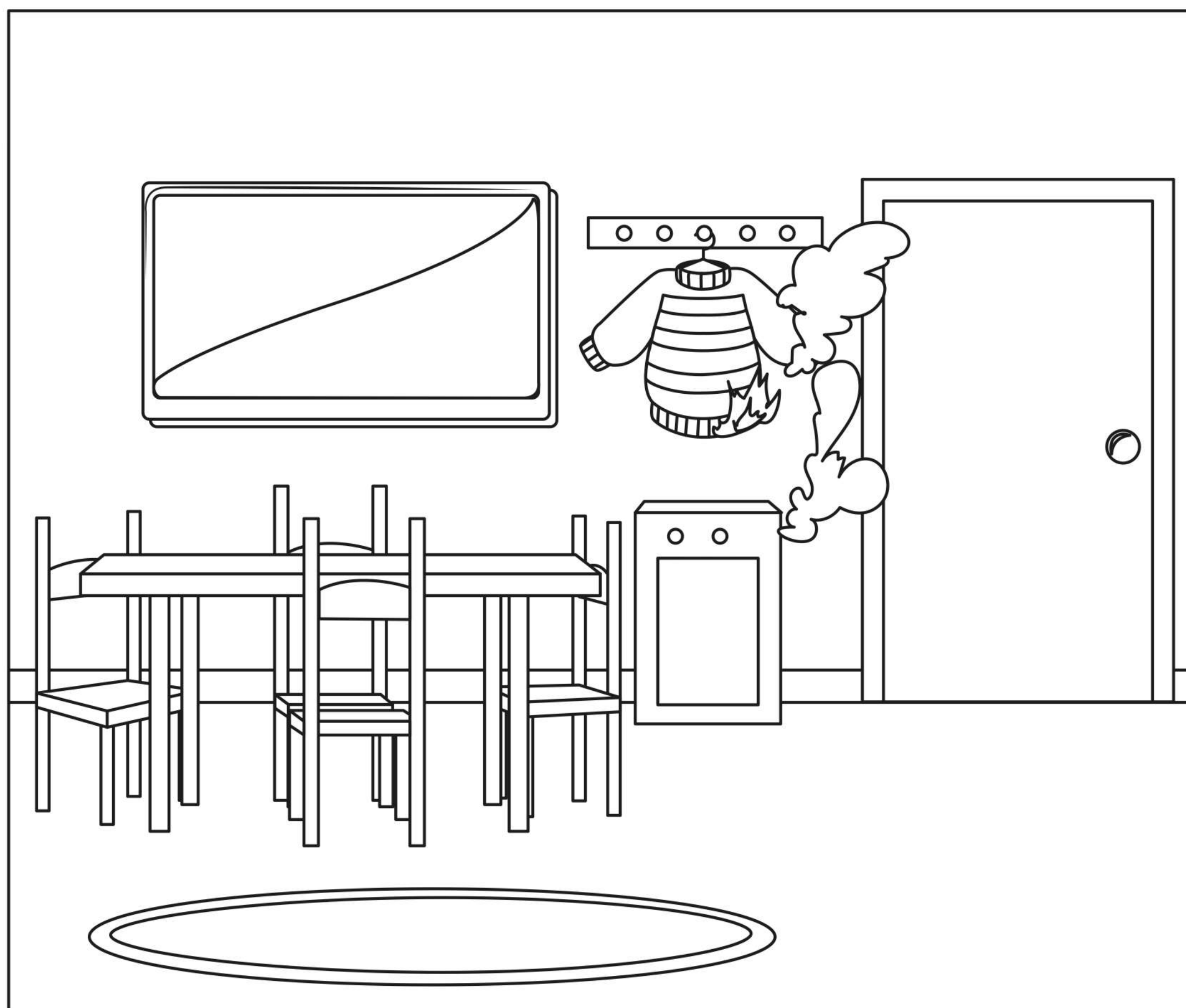
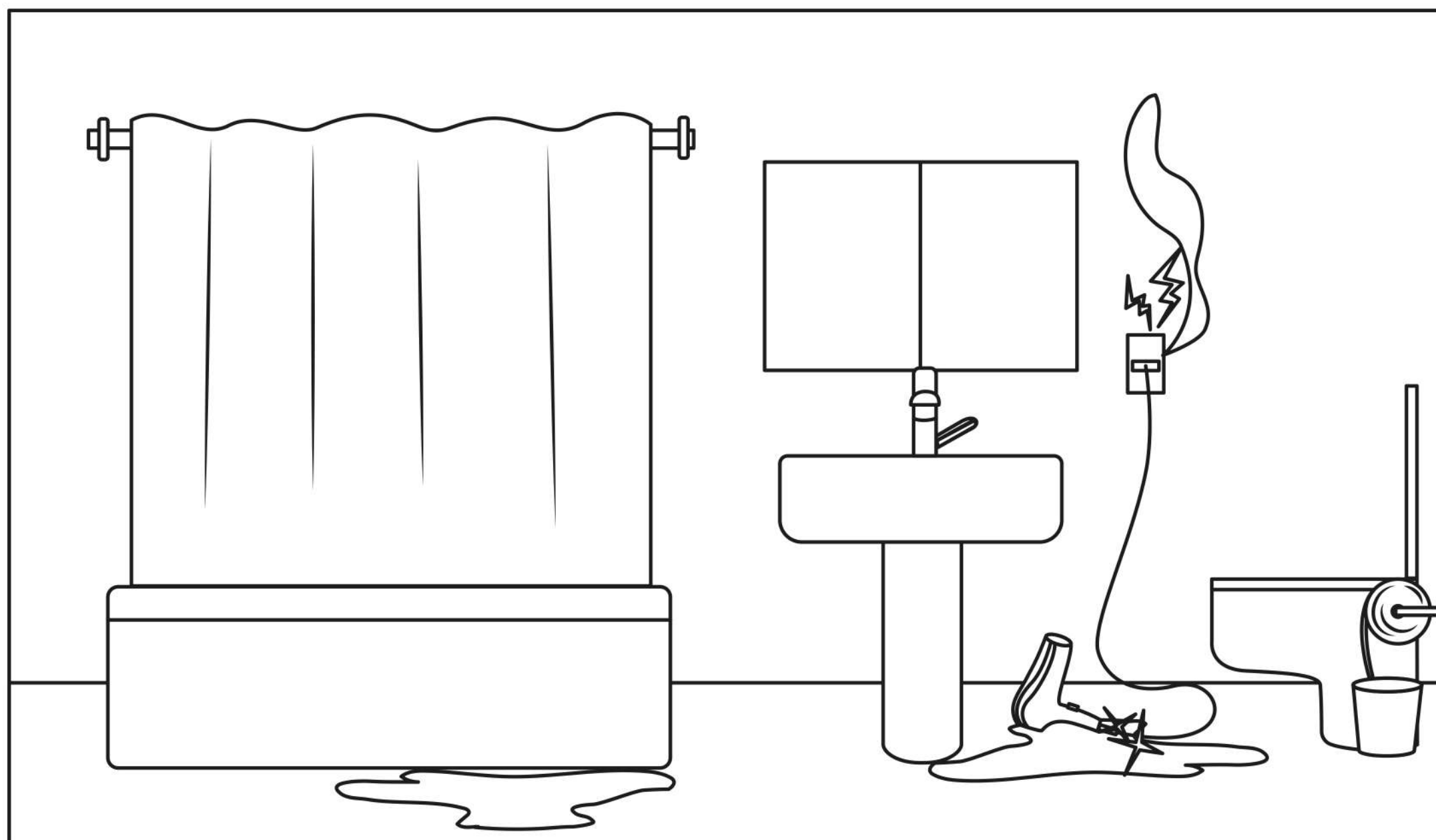

4-8 AÑOS



Centro de Referencia en Primeros Auxilios

PREVENCIÓN

DE INCIDENTES

Colorear los lugares peligrosos dentro de cada escena

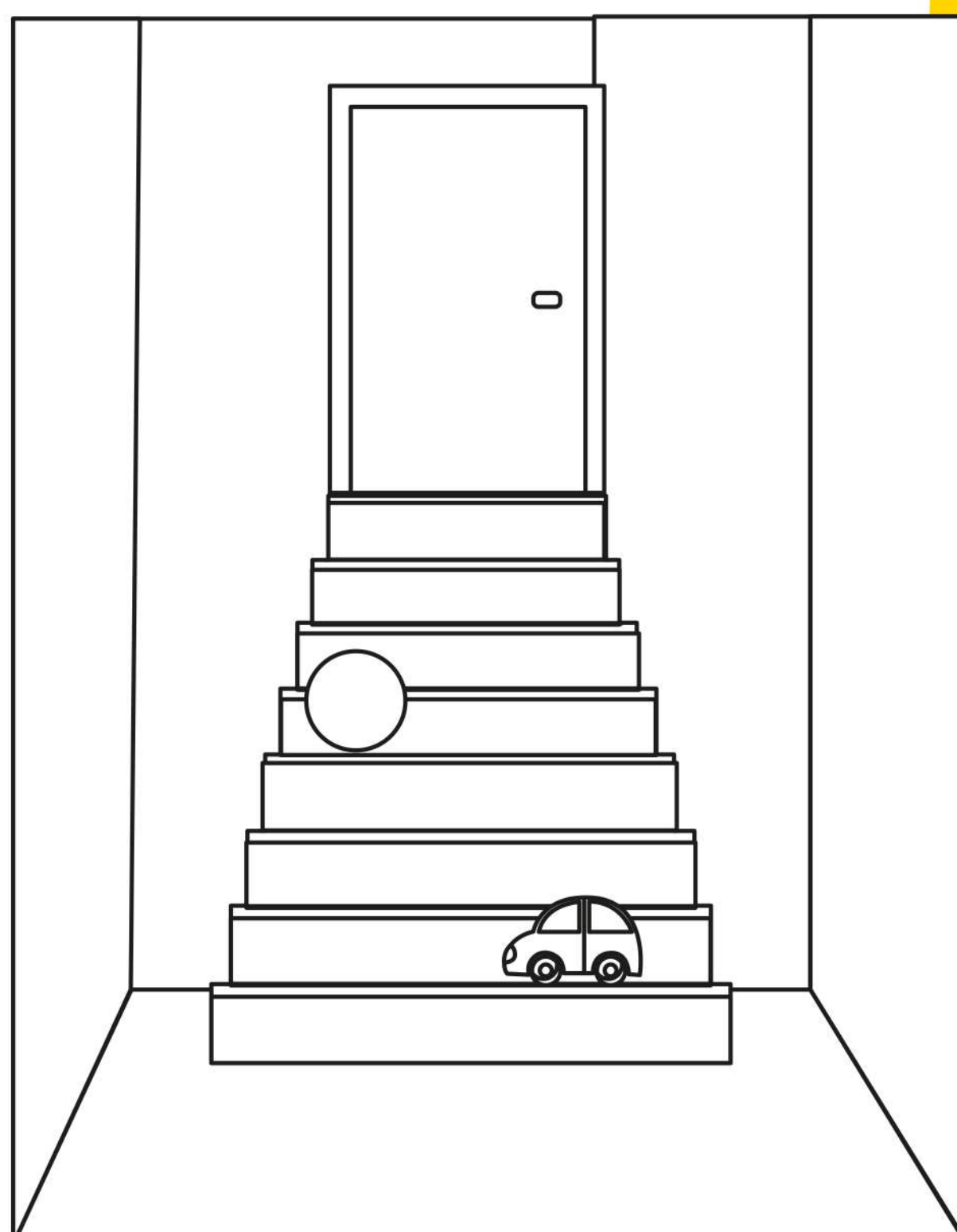
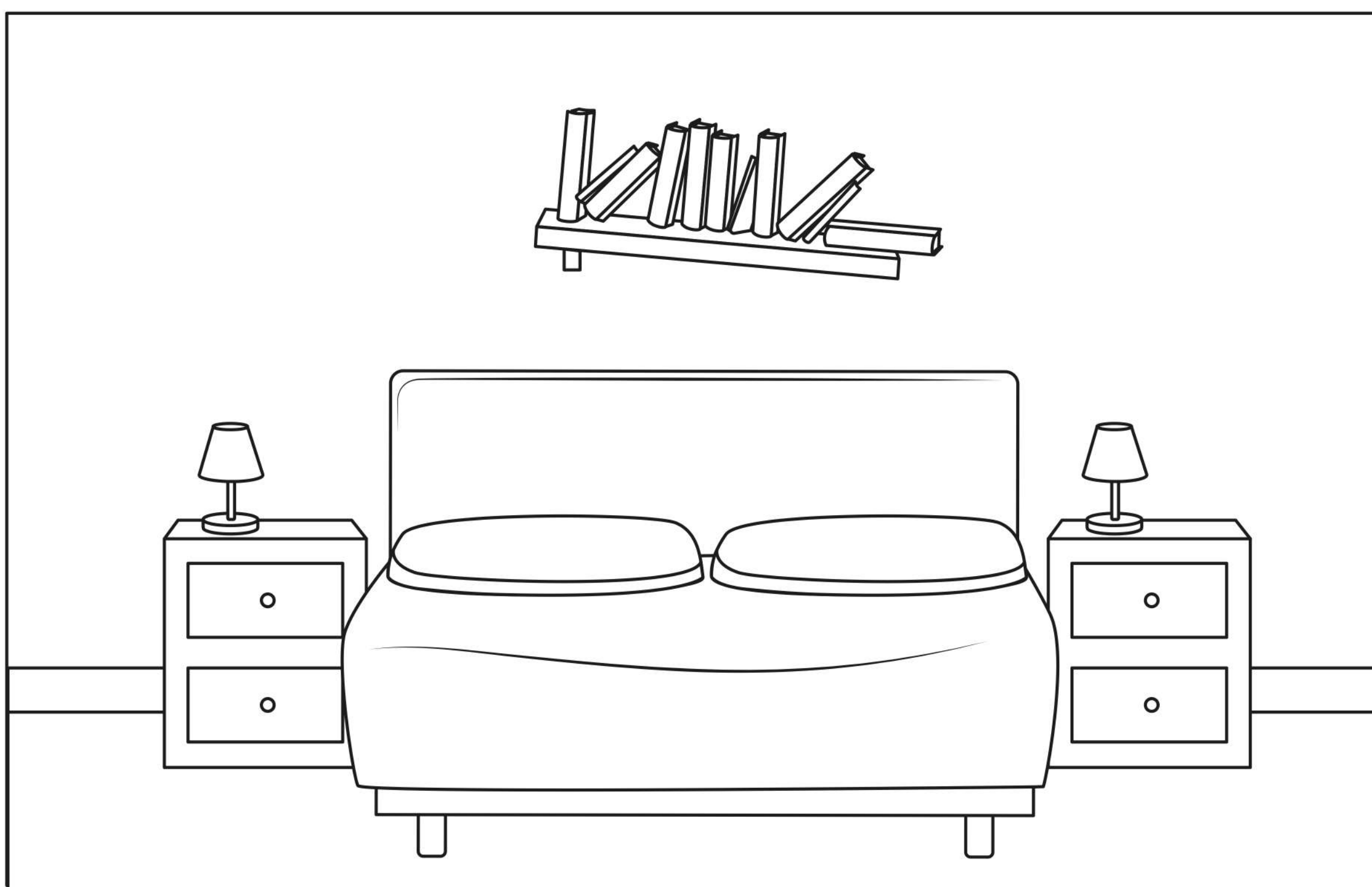

4-8 AÑOS



Centro de
Referencia en
Primeros Auxilios

BOTIQUÍN

Colorear las imágenes
que van **adentro del**
botiquín.

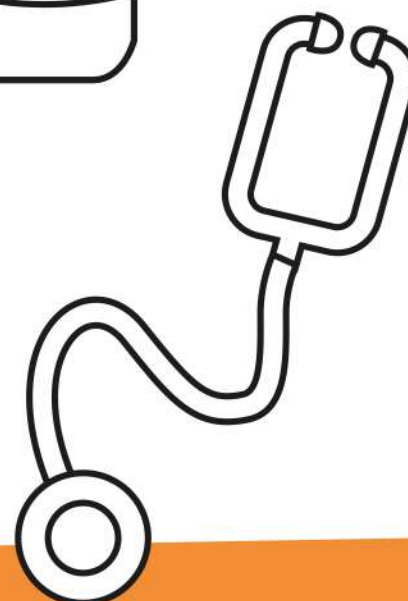
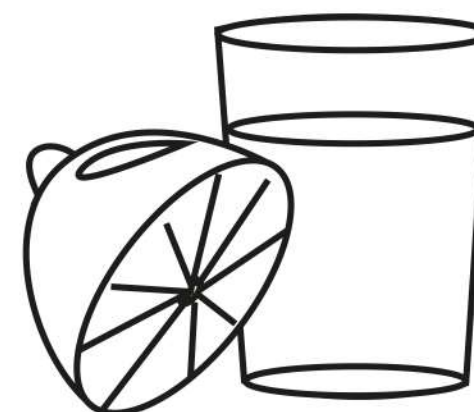
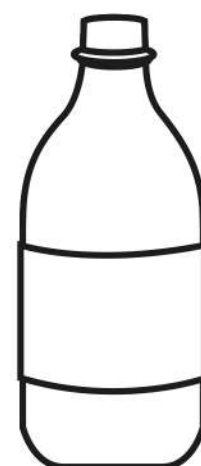
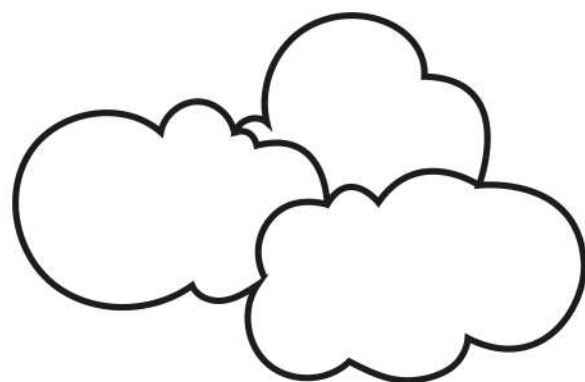
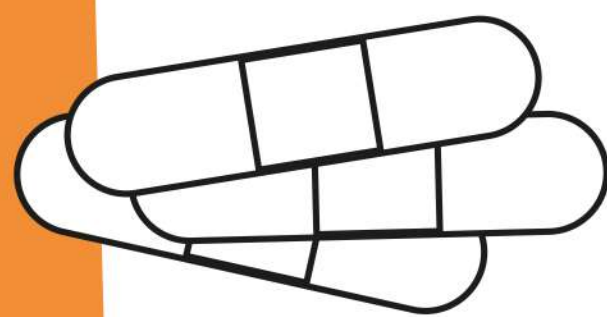
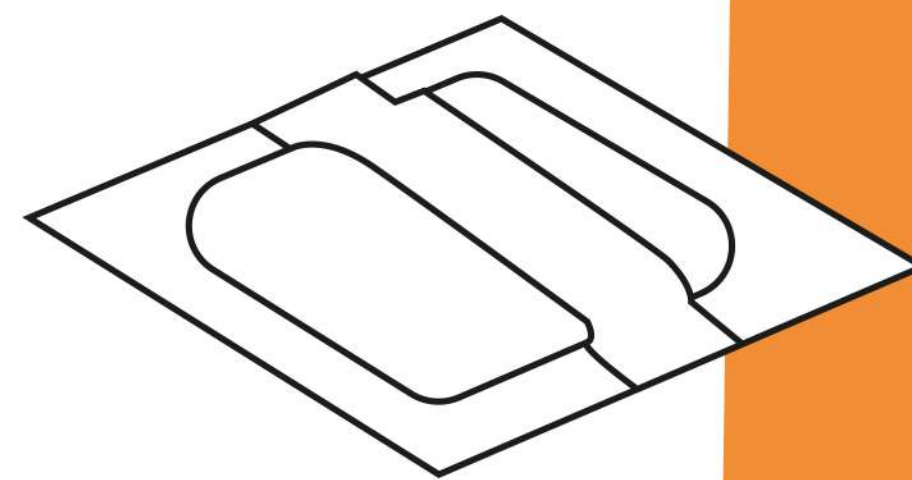
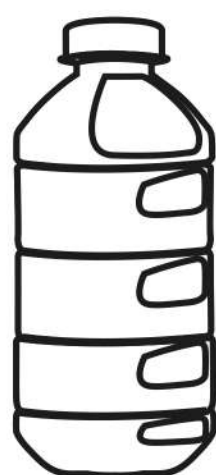
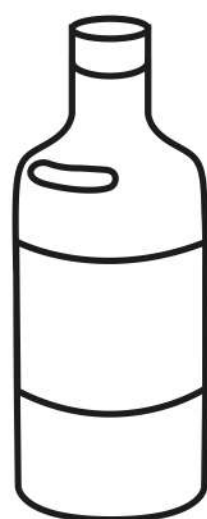
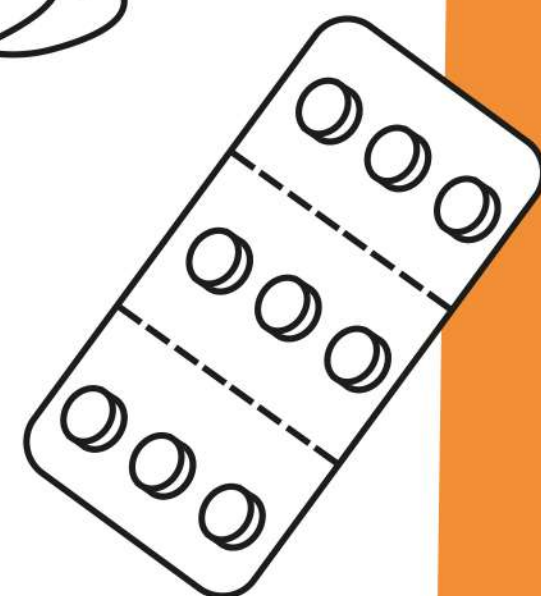
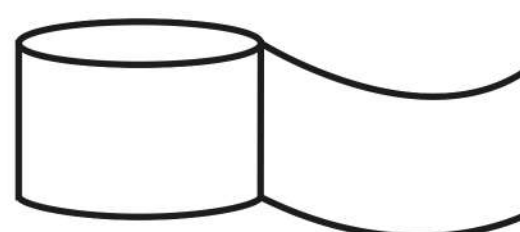
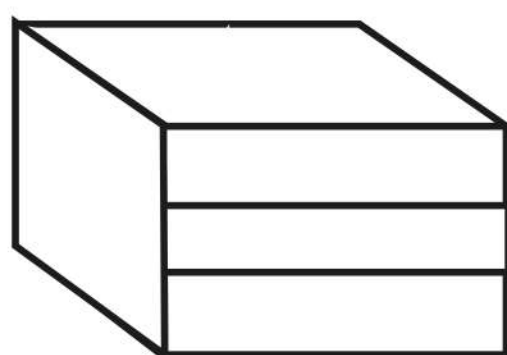
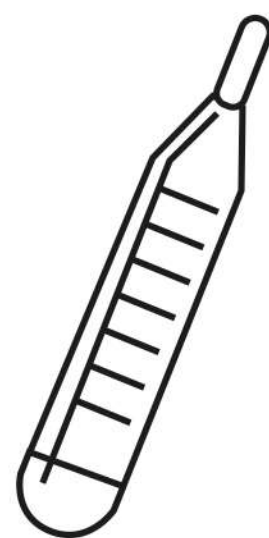
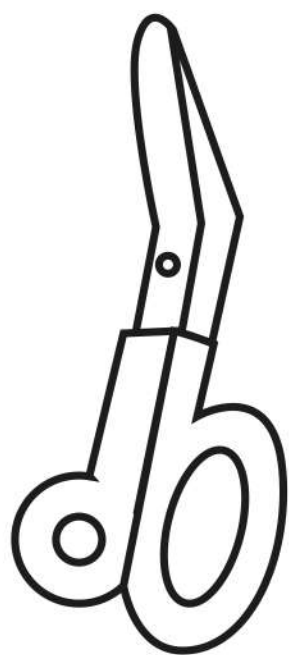
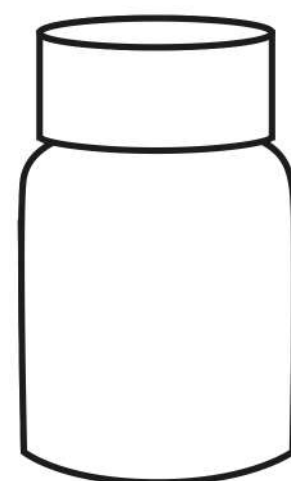
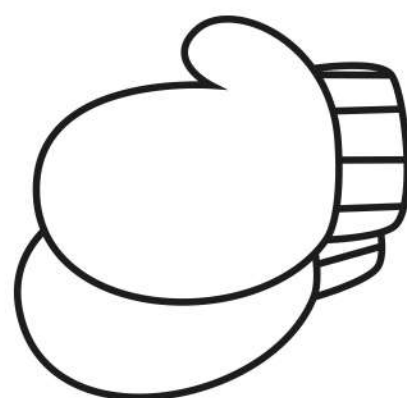
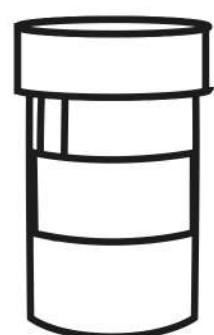
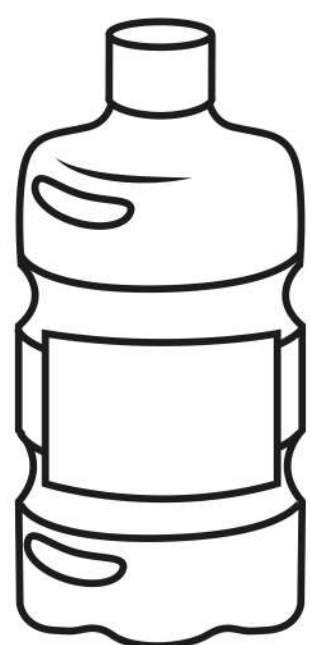
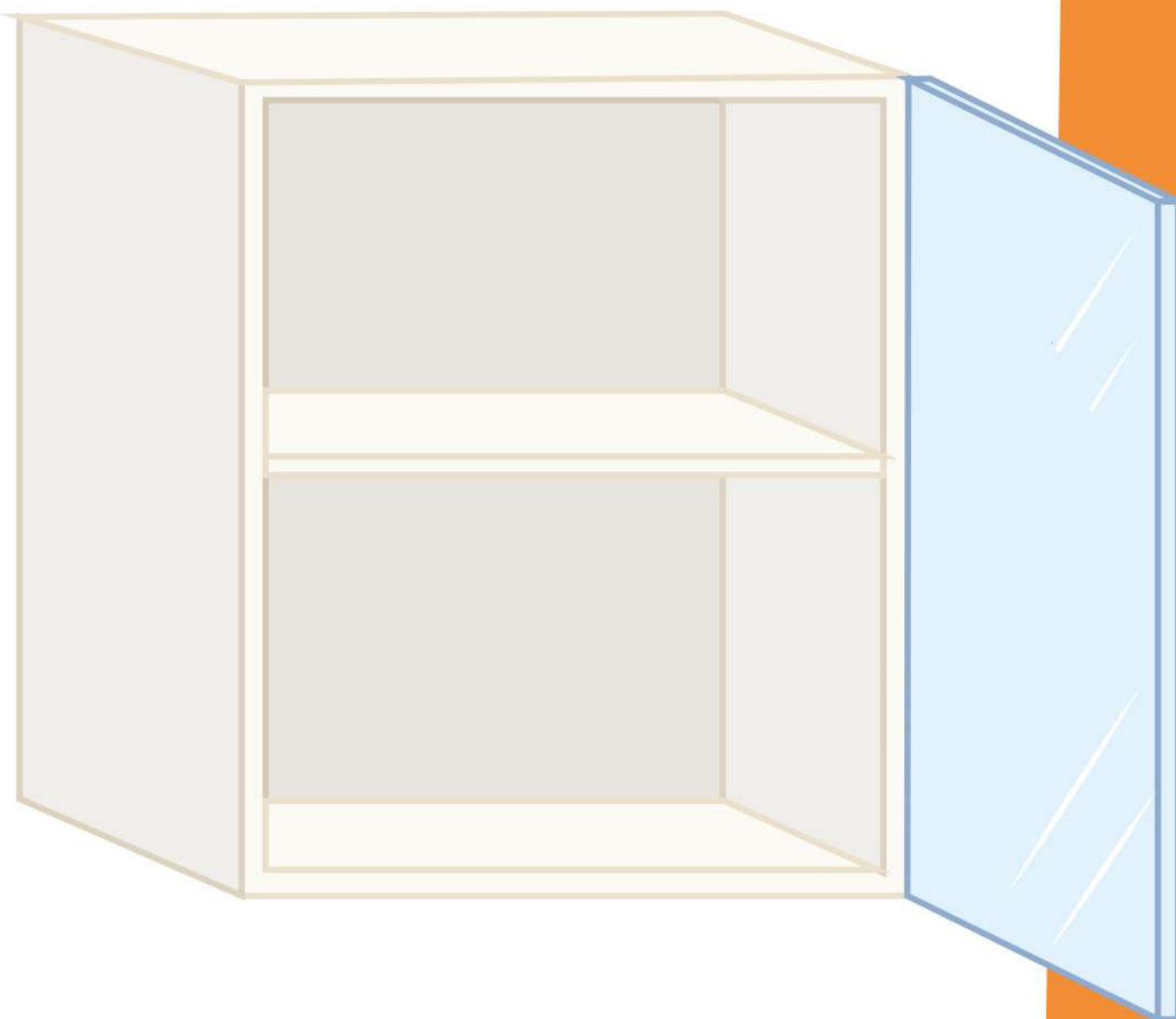

4-8 AÑOS



Centro de Referencia en Primeros Auxilios

RECONOCER Y ACTUAR ANTE UNA EMERGENCIA

Escriba en la casilla gris el número de teléfono al que le corresponde **cada vehículo.** Luego, colorear.

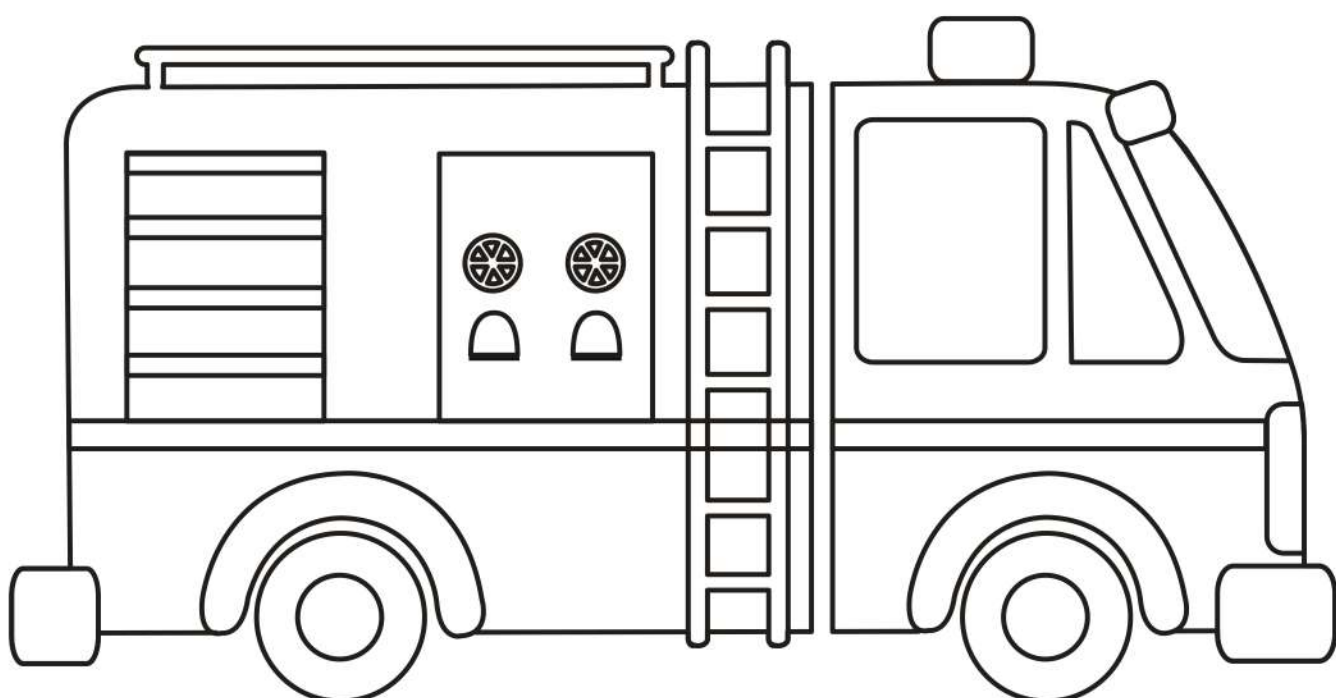
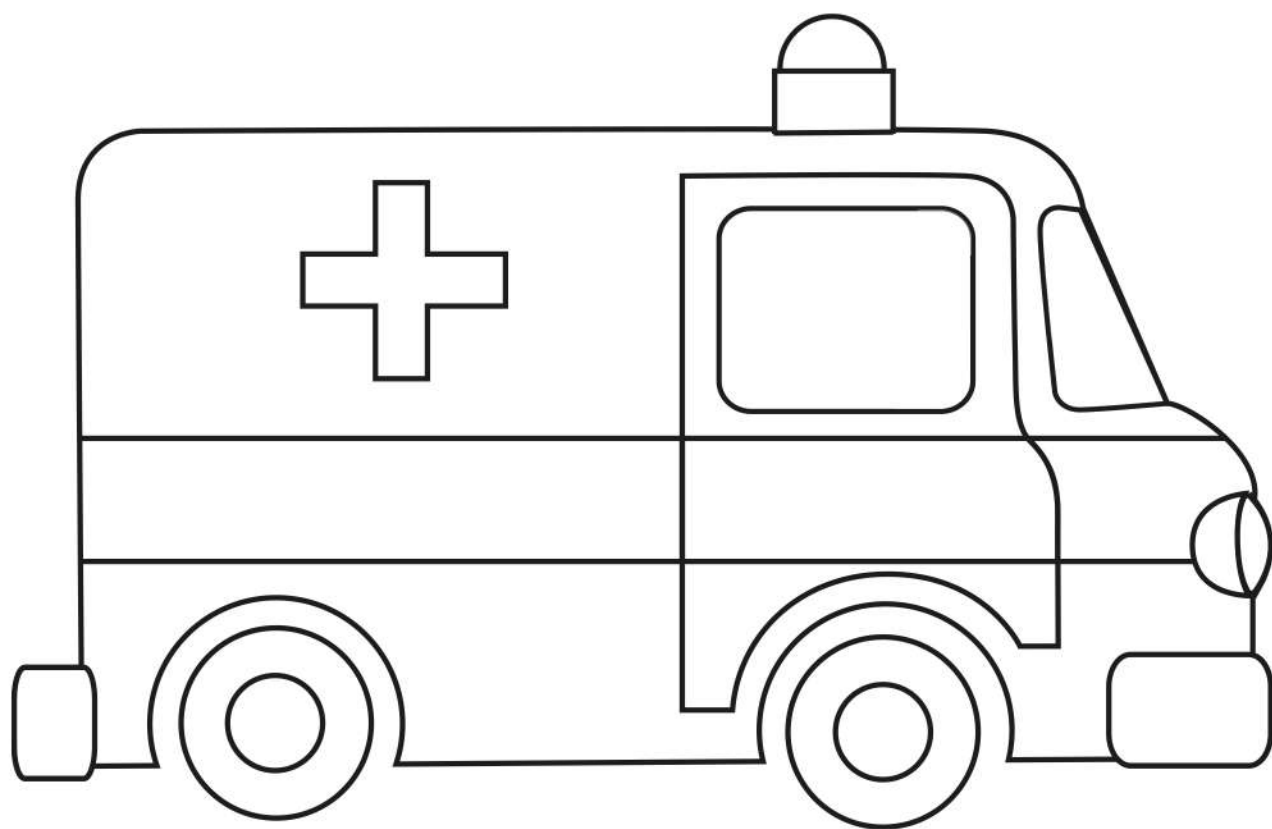
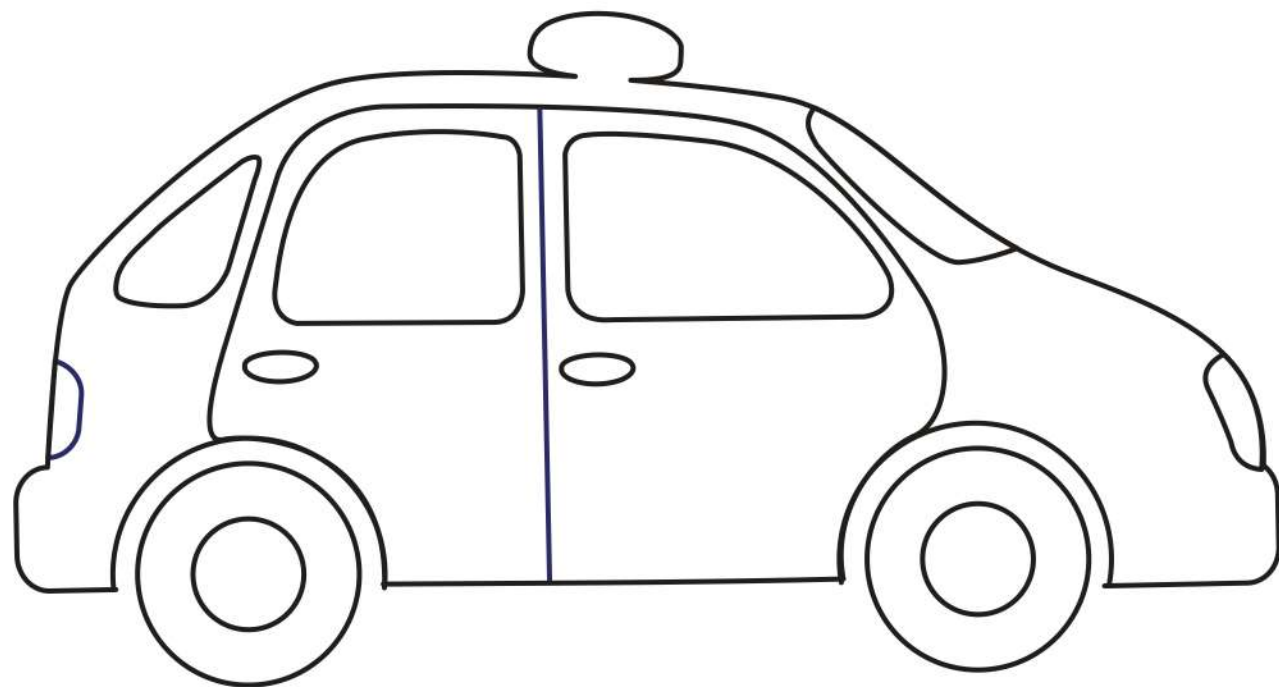

4-8 AÑOS



Centro de Referencia en Primeros Auxilios

HERIDAS Y HEMORRAGIAS

HERIDAS Y ABRASIONES

QUEMADURAS COTIDIANAS

Unir con flechas **cada situación.** Luego colorear.

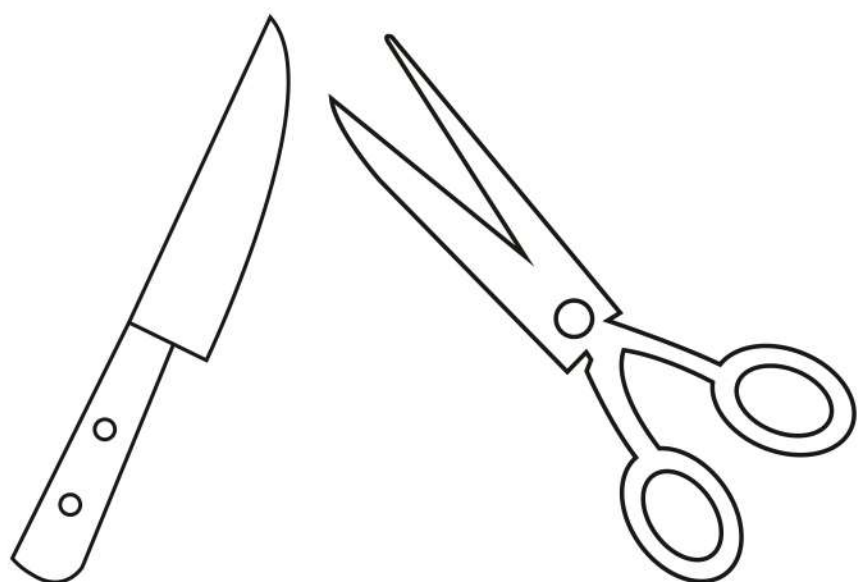
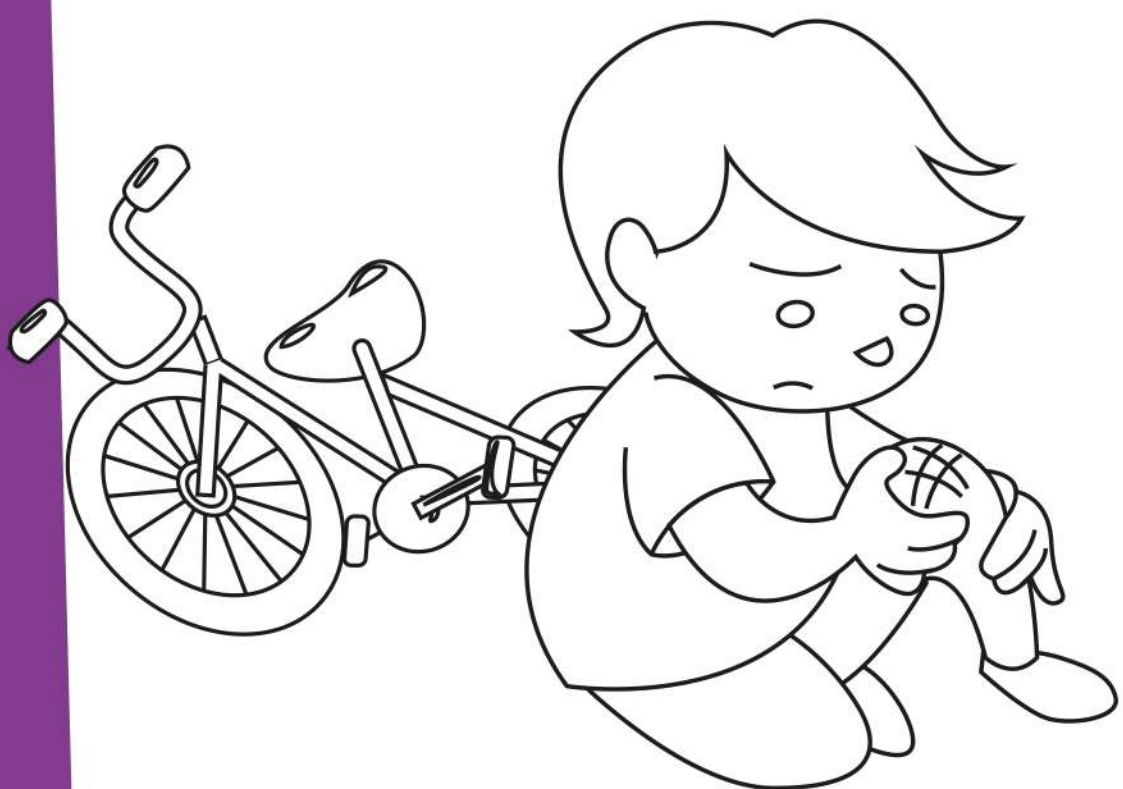
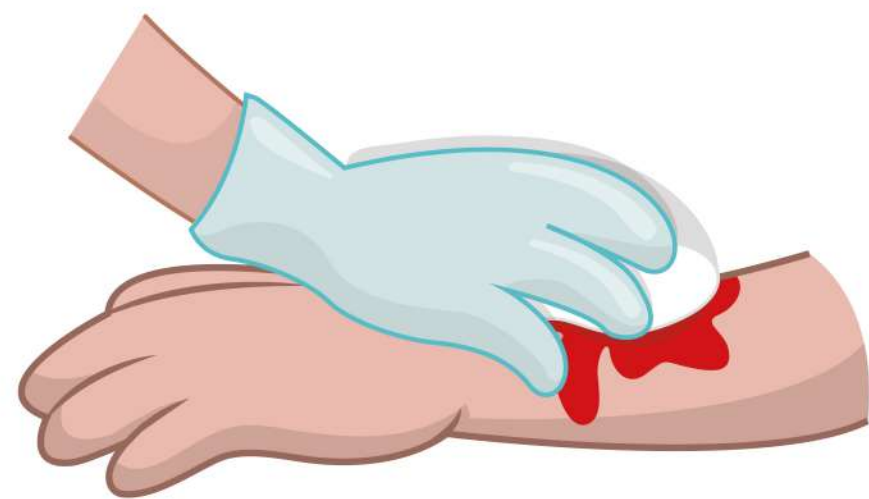

4-8 AÑOS



Centro de
Referencia en
Primeros Auxilios

REANIMACIÓN CARDIO PULMONAR (RCP)

ACCIDENTE CEREBROVASCULAR

ASFIXIA Y MANIOBRA DE DESOBSTRUCCIÓN

Colorear igual a la **imagen en color.**

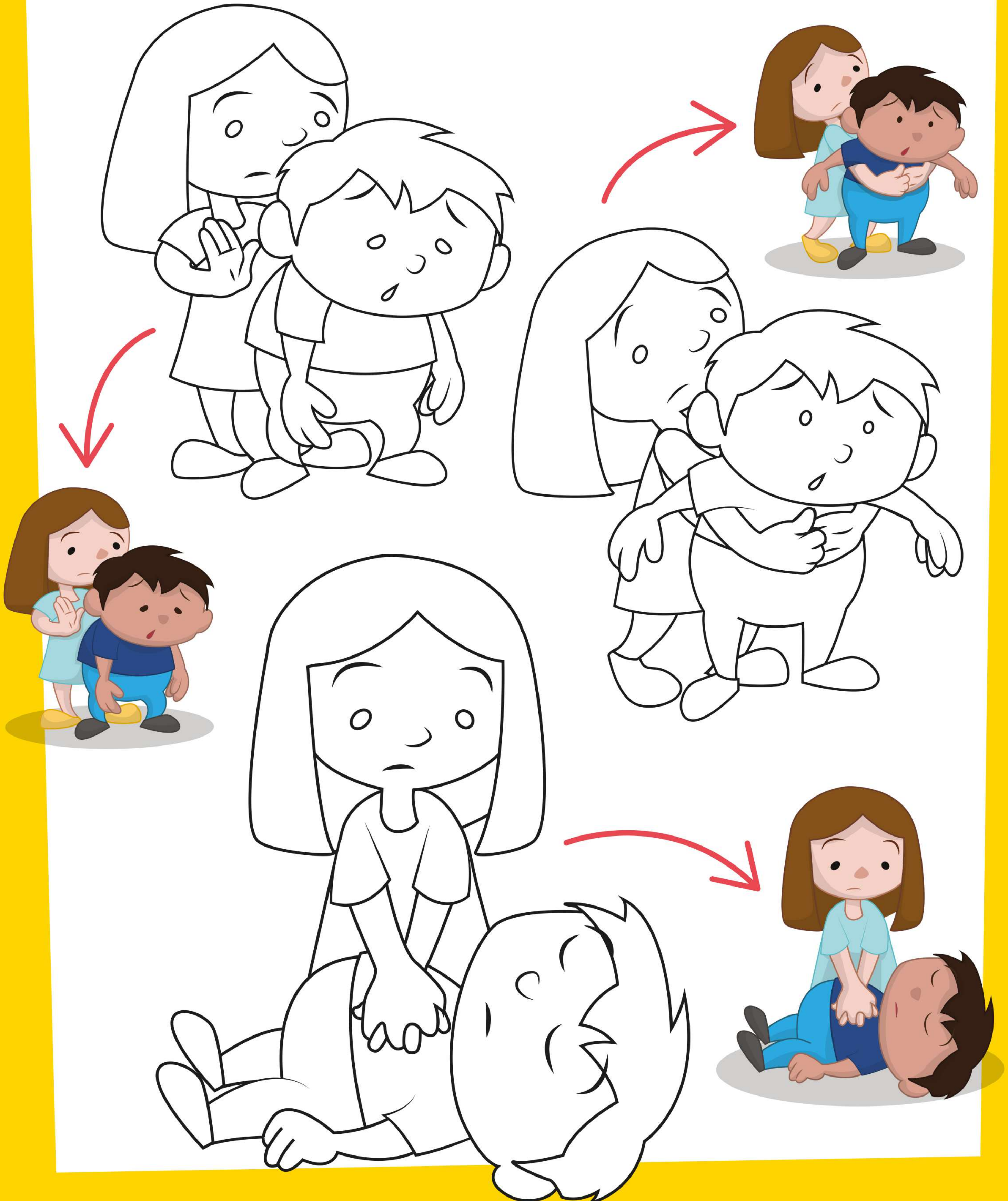

4-8 AÑOS



Centro de Referencia en Primeros Auxilios

INTOXICACIONES

Tachar los productos **tóxicos**.

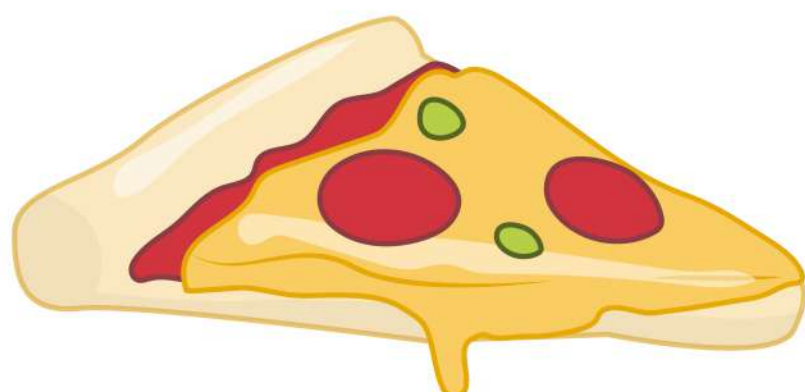
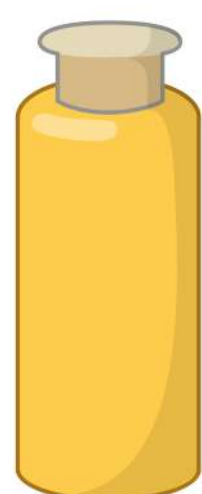
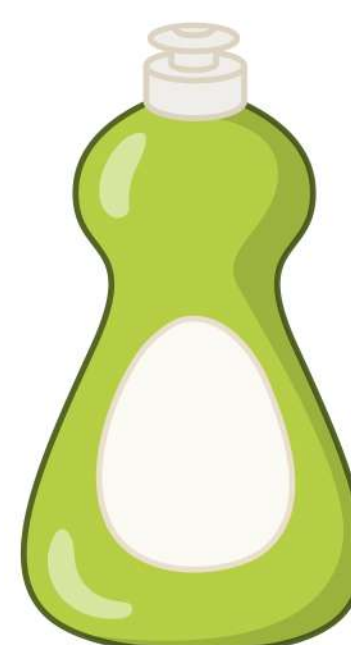
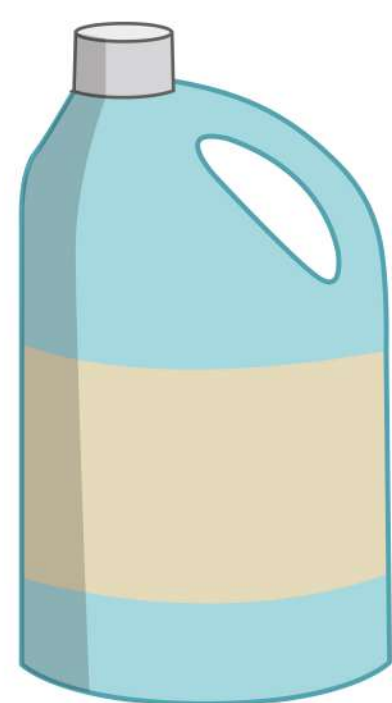

4-8 AÑOS



Centro de Referencia en Primeros Auxilios

ALTERACIONES PRODUCIDAS

POR FRÍO O CALOR

¿Qué podemos hacer para no sufrir las alteraciones del producidas por **el frío o el calor.** Unir con flechas.



4-8 AÑOS



Centro de Referencia en Primeros Auxilios

PICADURA DE INSECTOS

MORDEDURA DE ANIMALES

Unir con flechas el tipo de **mordedura/picadura** que se corresponde con cada animal/insecto.

