

4-8 AÑOS



Centro de Referencia en Primeros Auxilios

PREVENCIÓN DE INCIDENTES

Colorear los **lugares peligrosos** dentro de cada escena

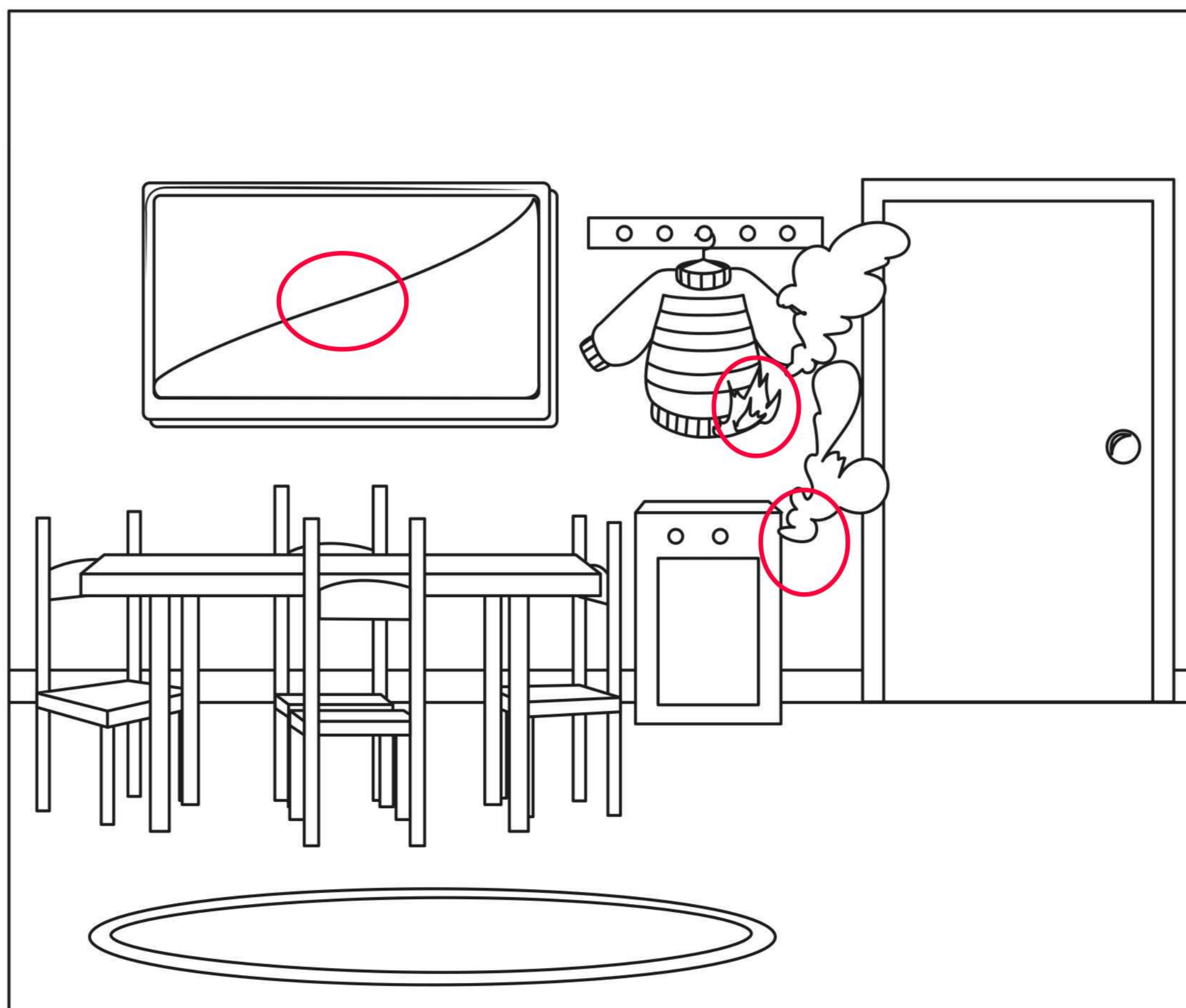
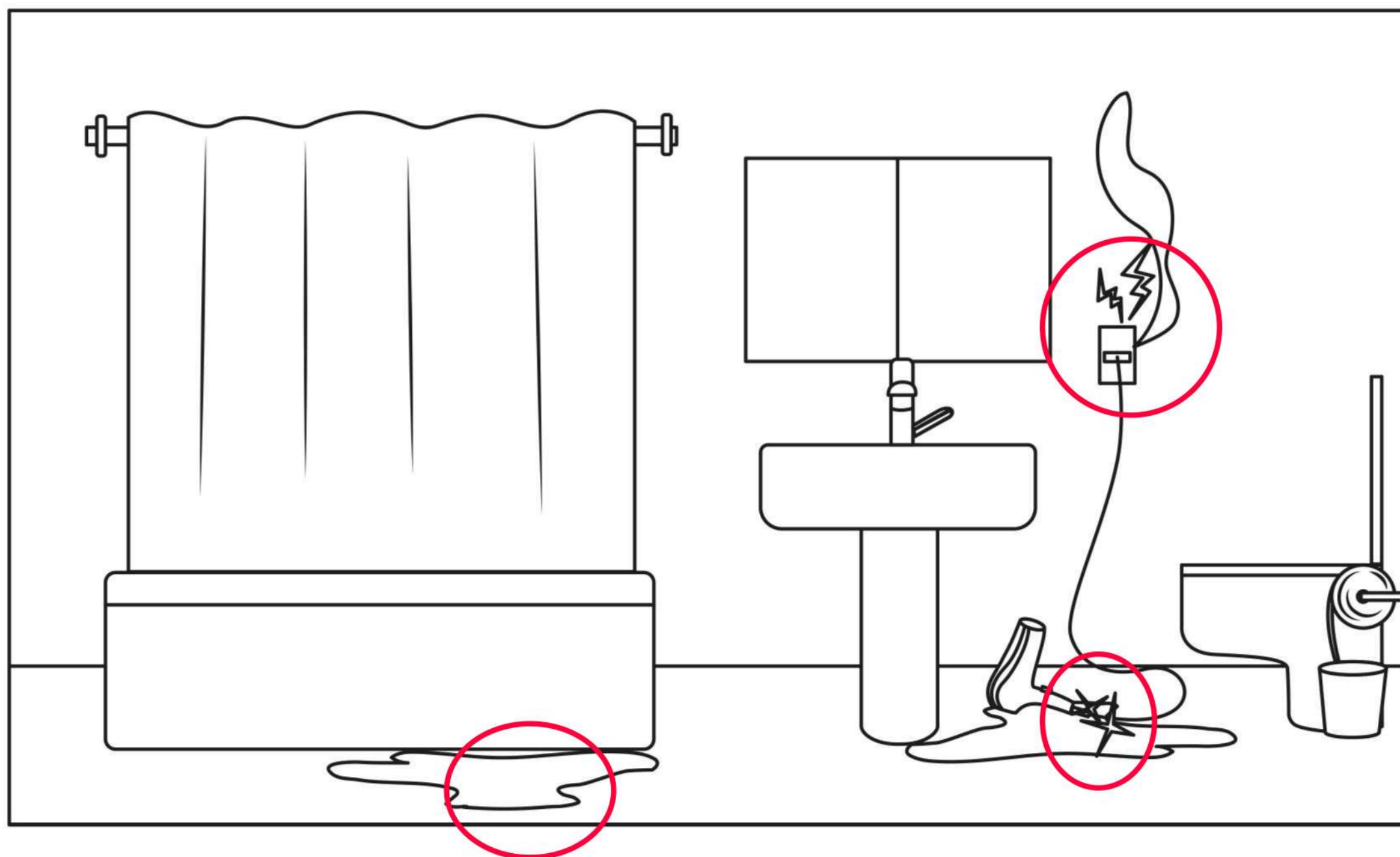

4-8 AÑOS



Centro de Referencia en Primeros Auxilios

PREVENCIÓN DE INCIDENTES

Colorear los **lugares peligrosos** dentro de cada escena

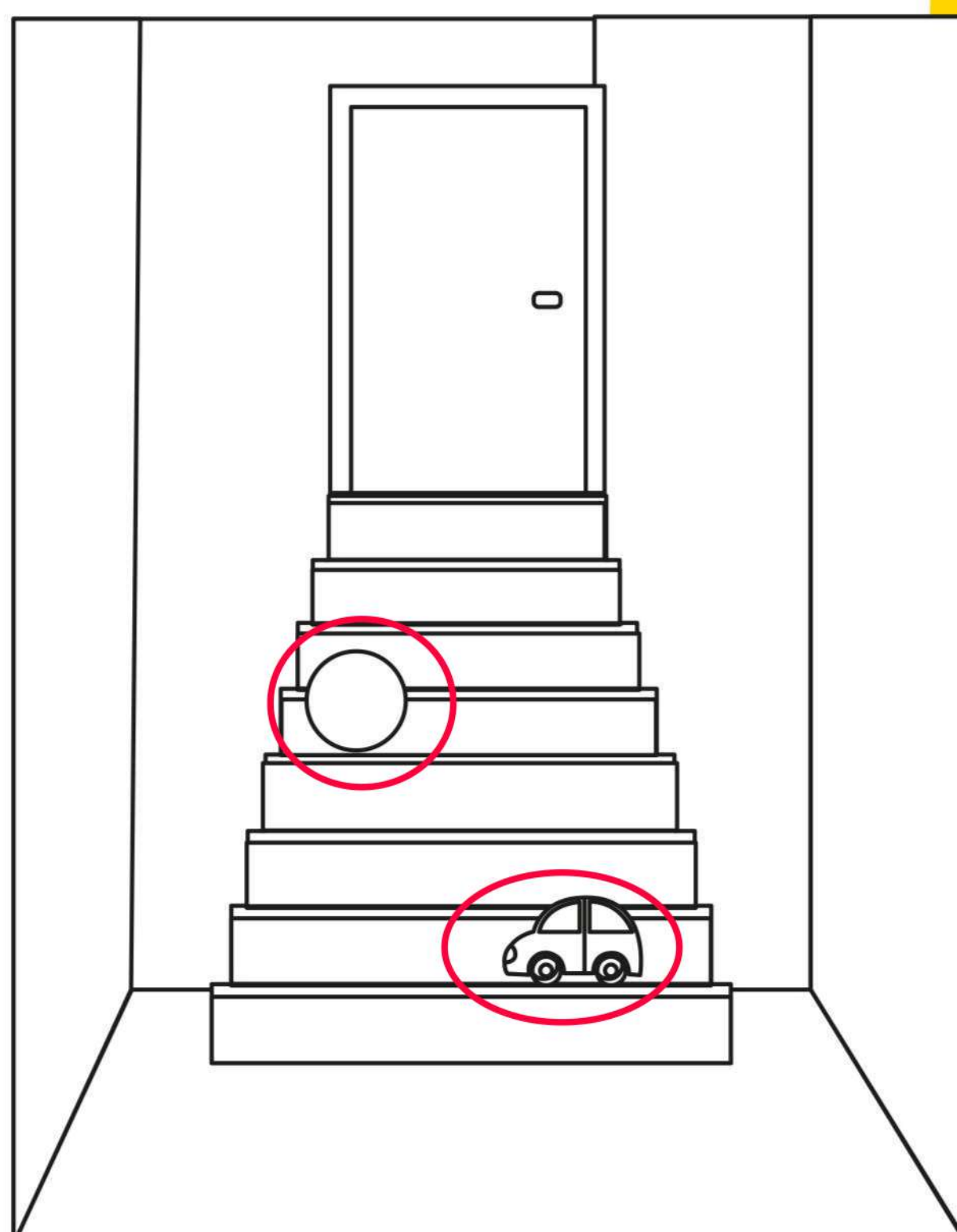
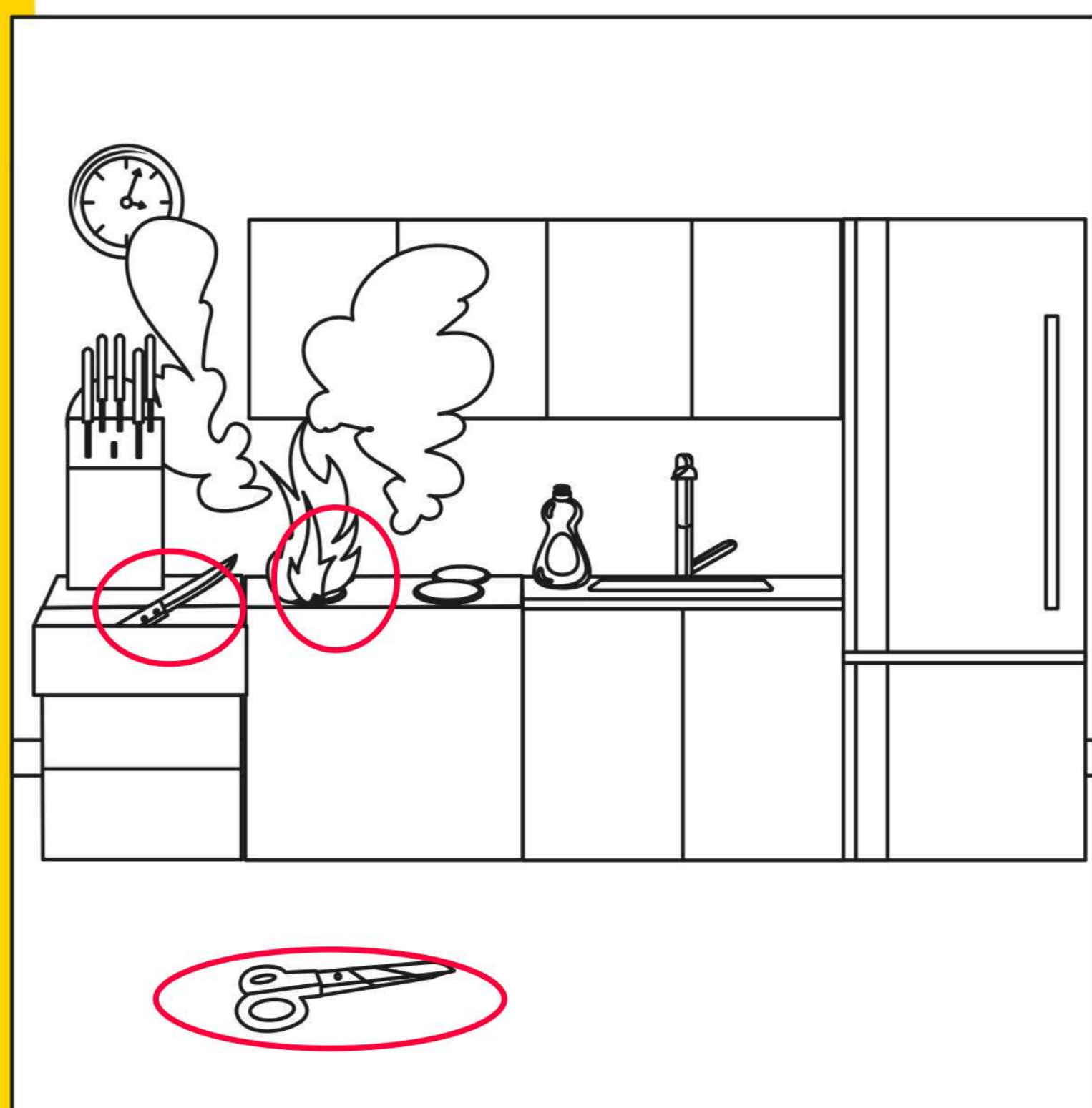
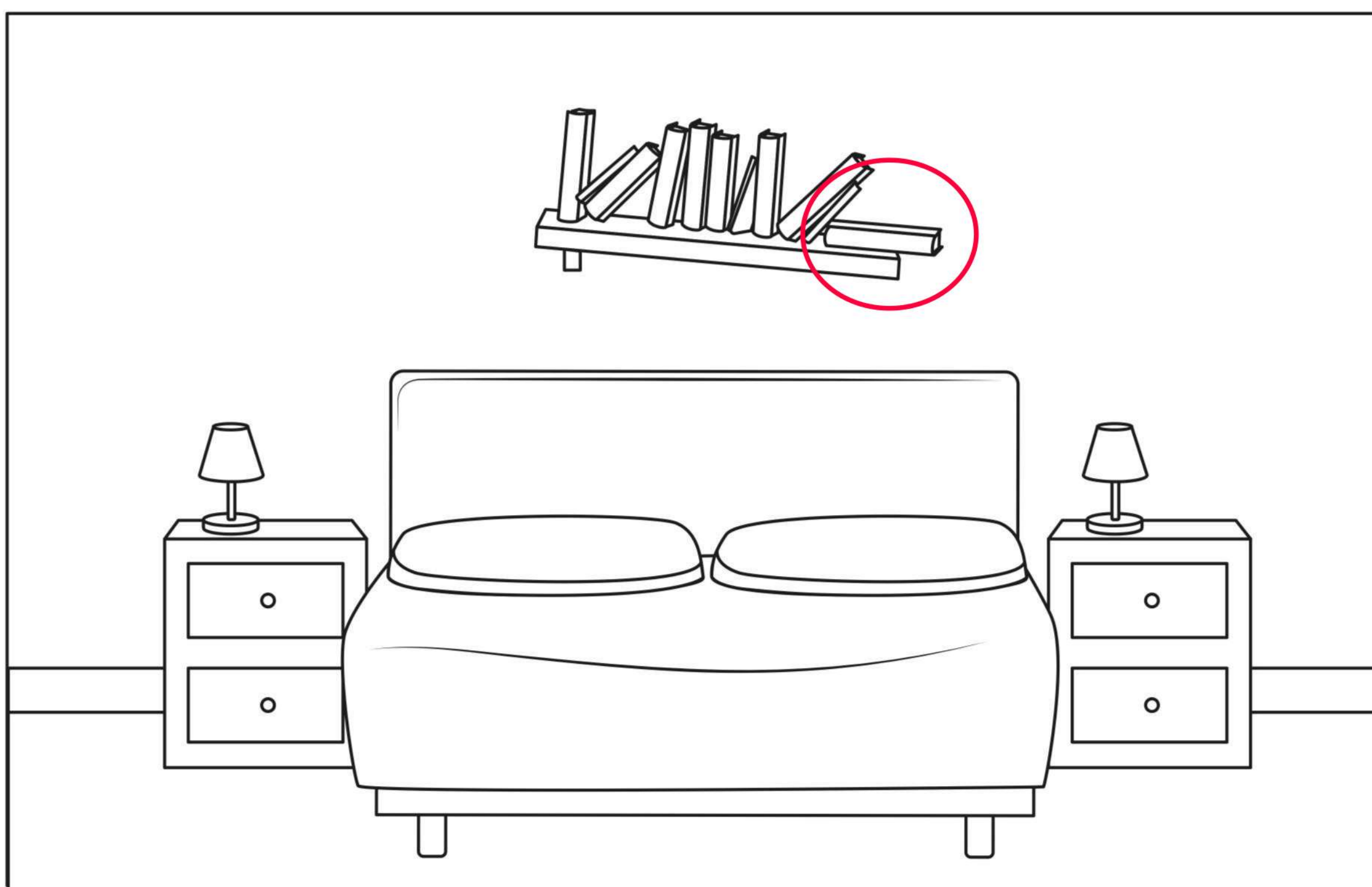

4-8 AÑOS



Centro de Referencia en Primeros Auxilios

BOTIQUÍN

Colorear las imágenes que van **adentro del botiquín.**

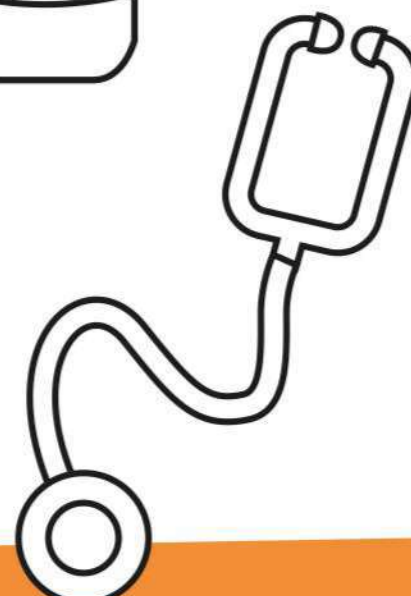
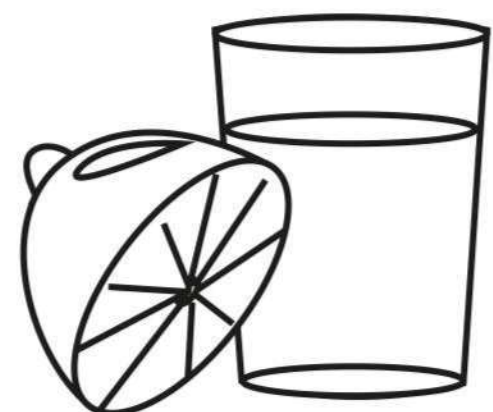
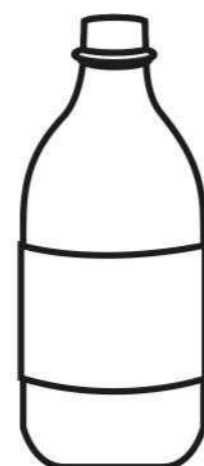
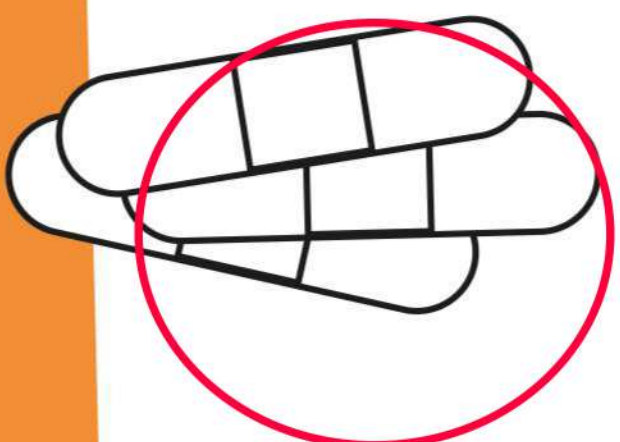
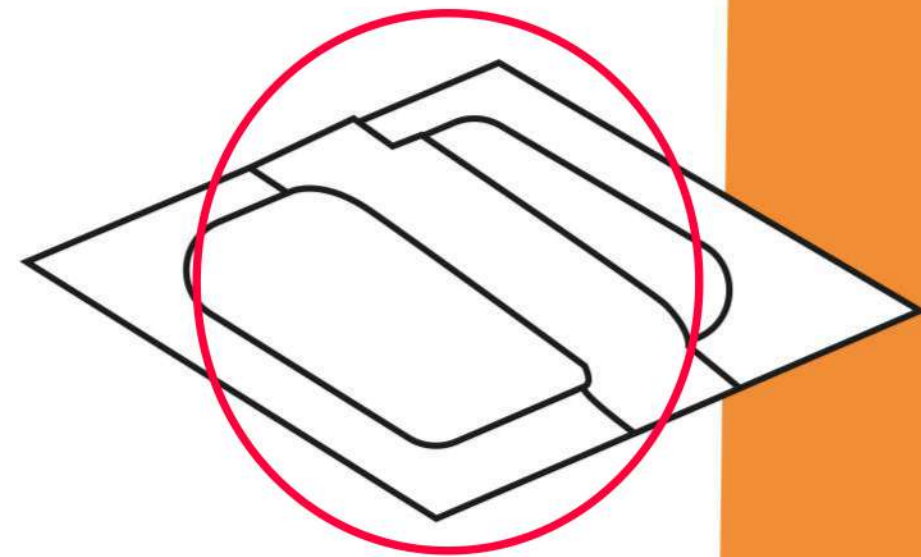
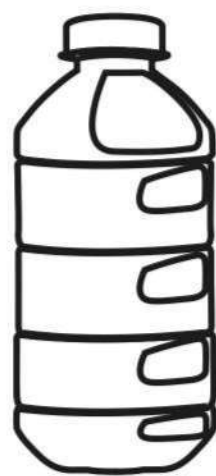
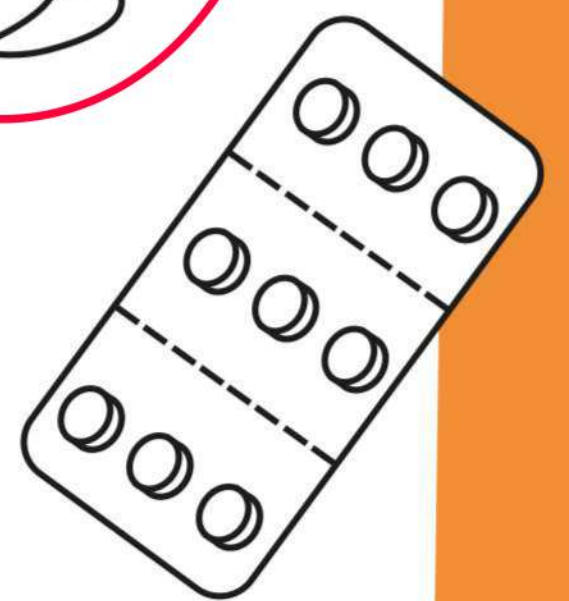
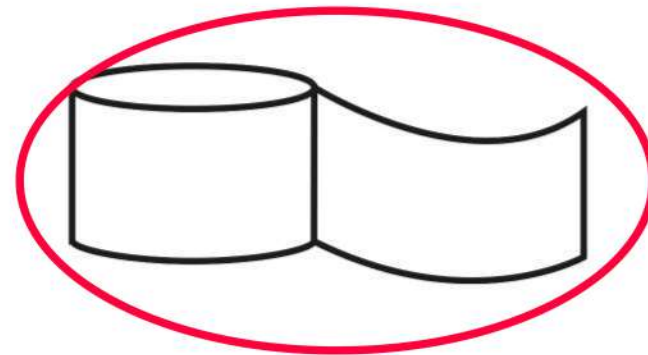
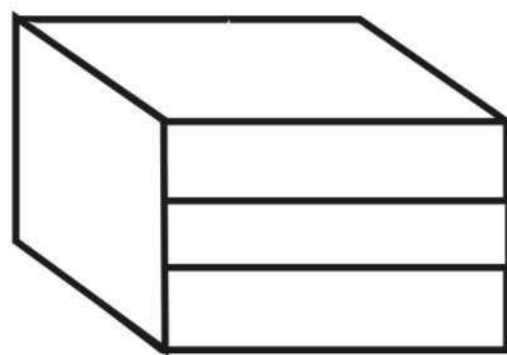
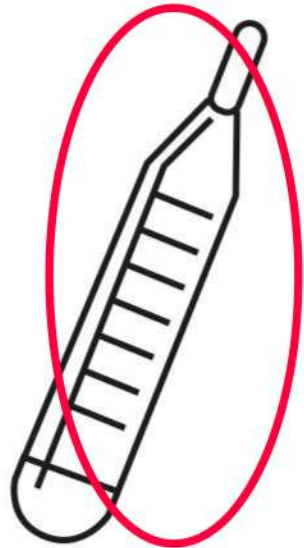
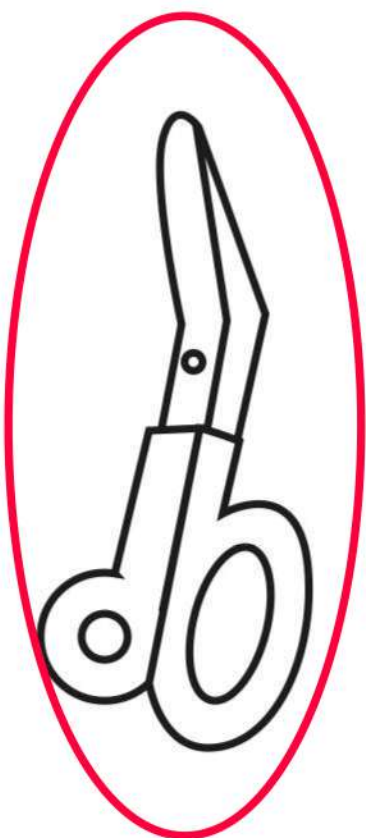
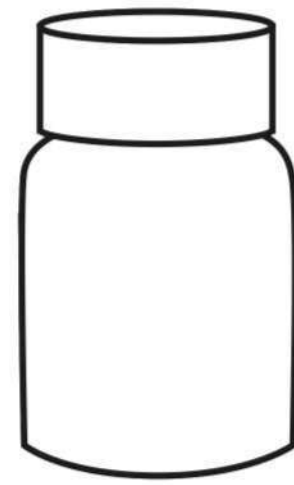
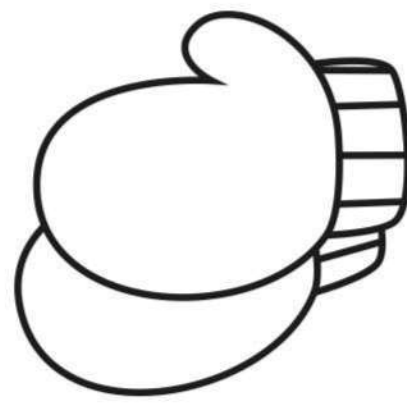
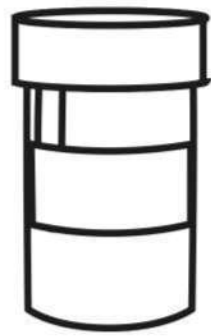
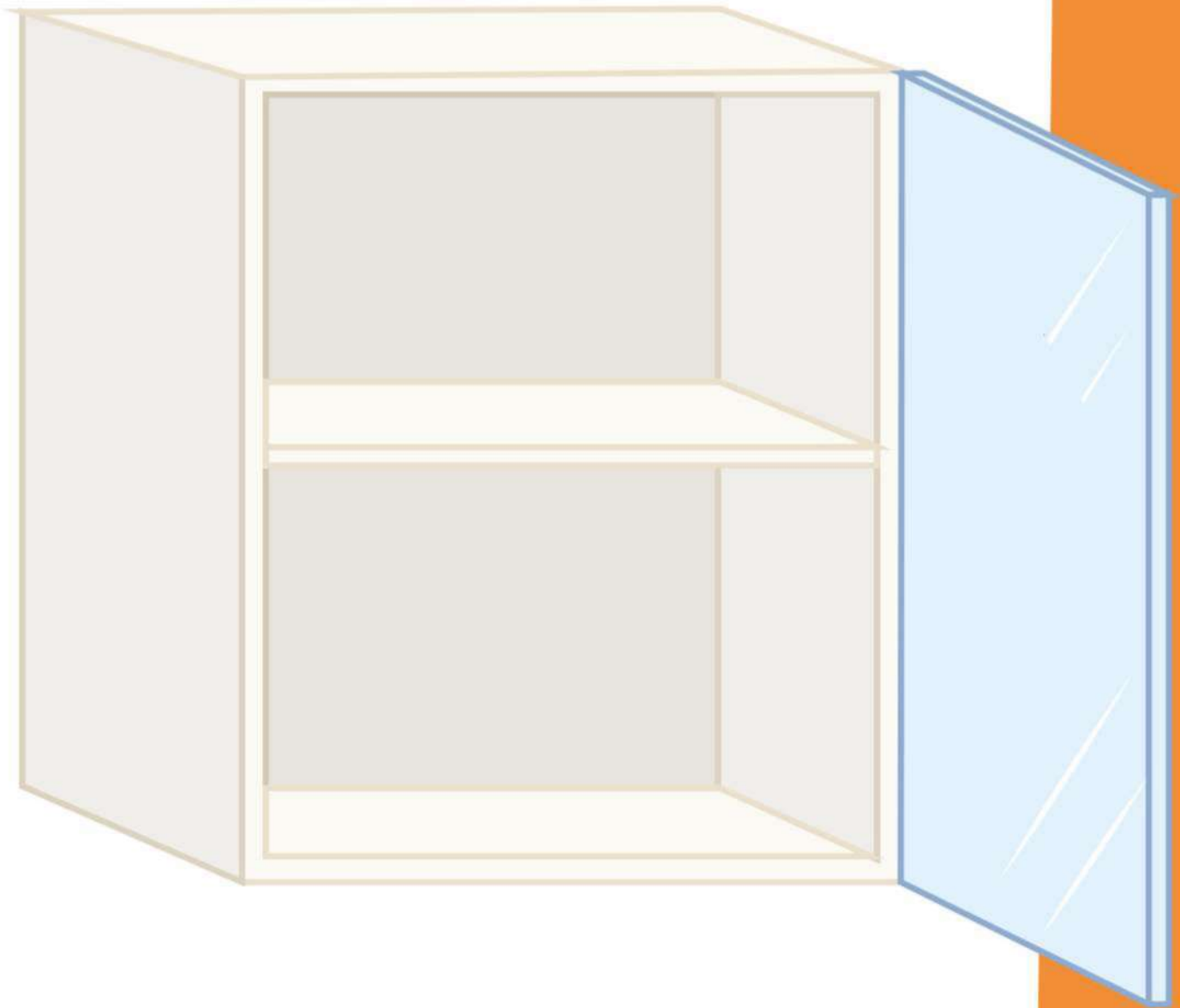

4-8 AÑOS



Centro de
Referencia en
Primeros Auxilios

RECONOCER Y ACTUAR ANTE UNA EMERGENCIA

Escriba en la casilla gris el número de teléfono al que
le corresponde **cada vehículo.** Luego, colorear.

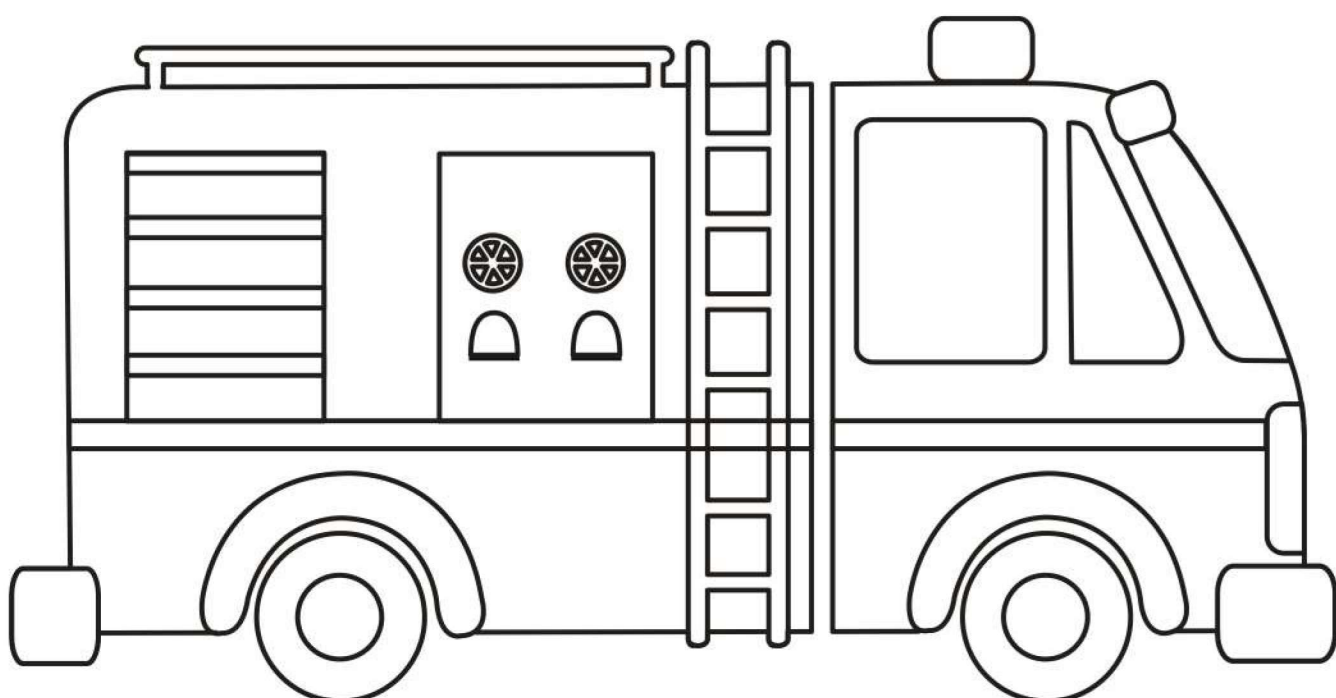
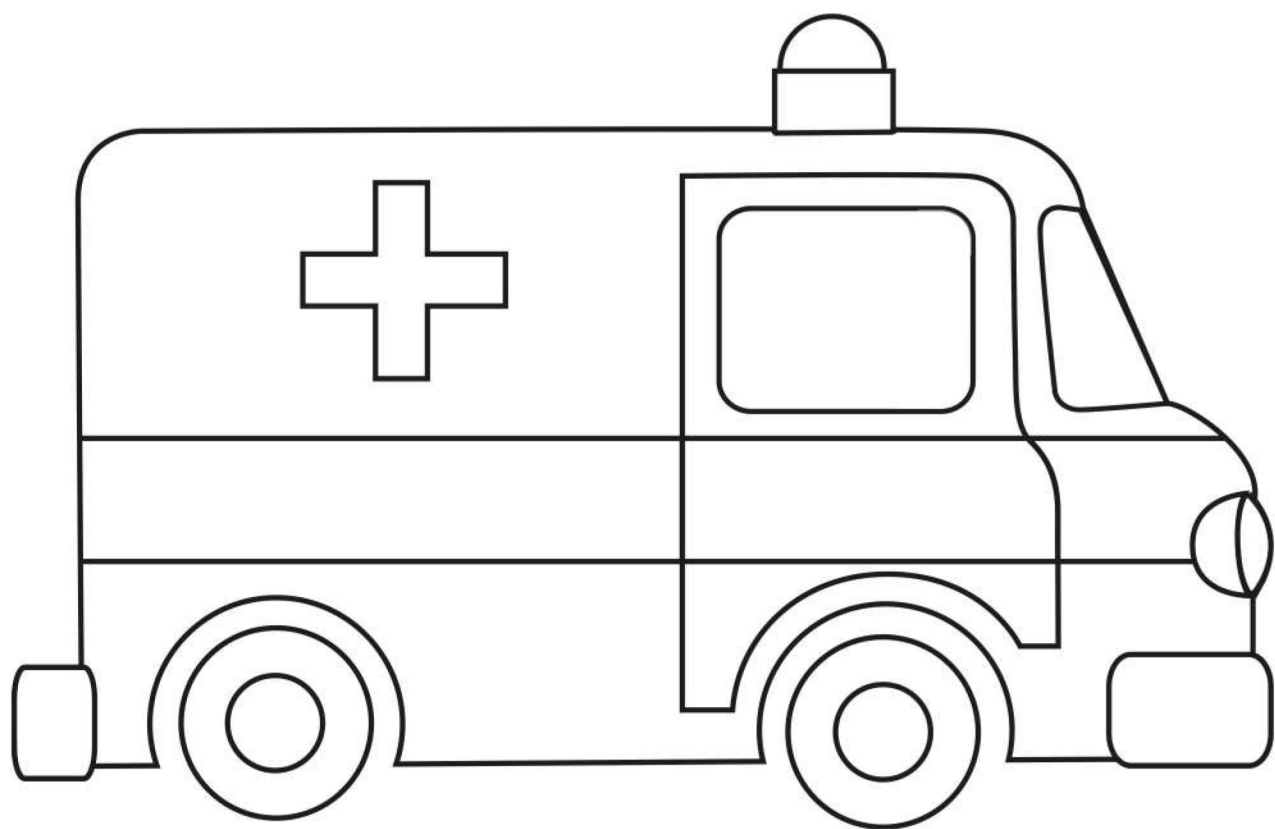
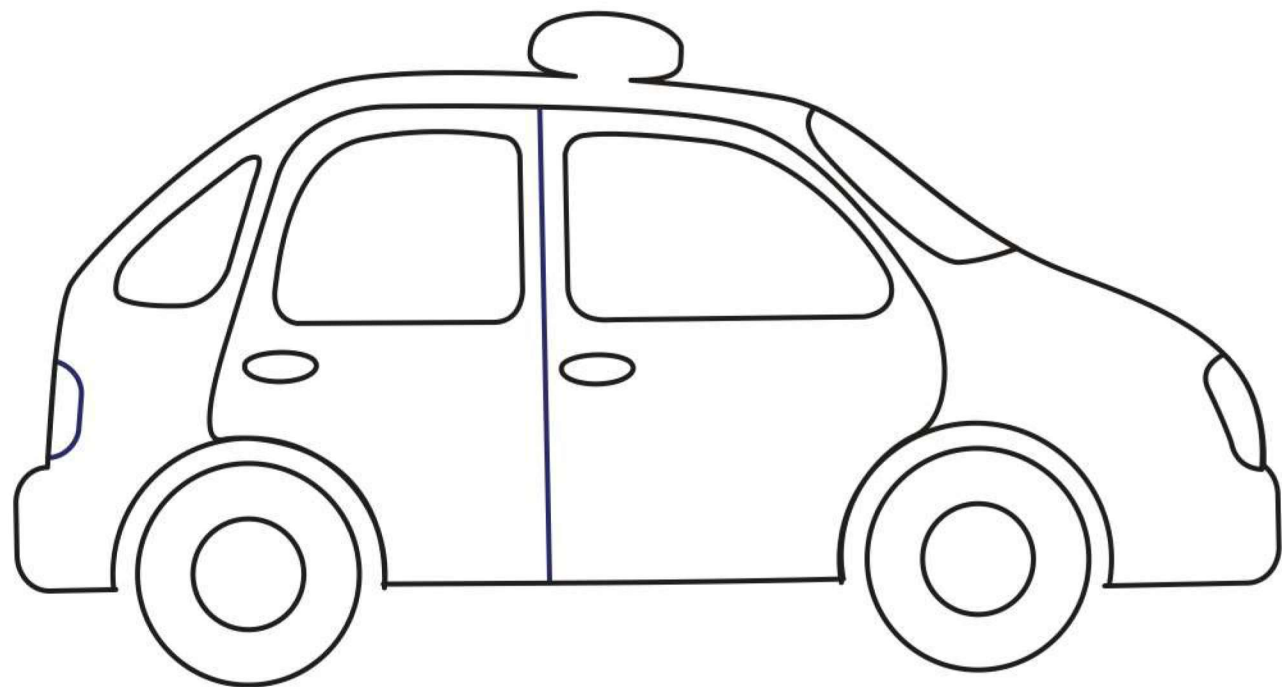

4-8 AÑOS



Centro de Referencia en Primeros Auxilios

HERIDAS Y HEMORRAGIAS

HERIDAS Y ABRASIONES

QUEMADURAS COTIDIANAS

Unir con flechas **cada situación.** Luego colorear.

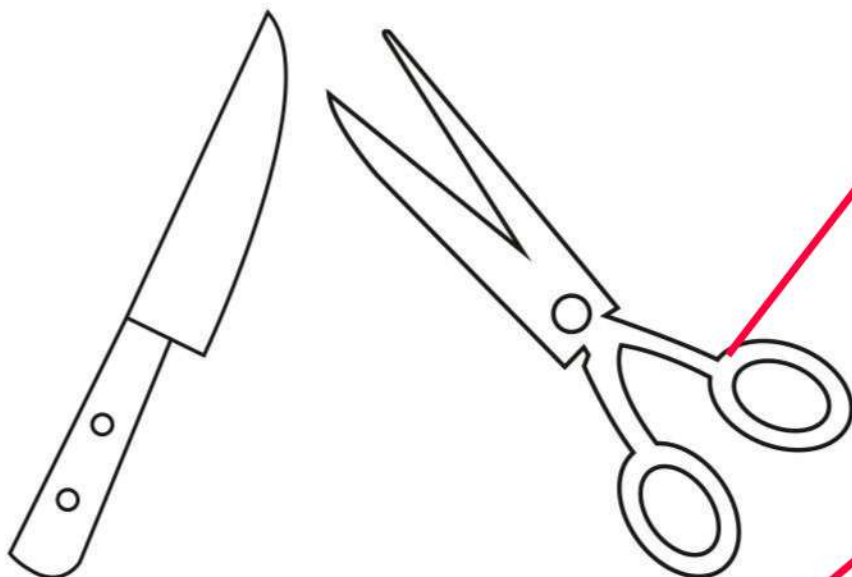
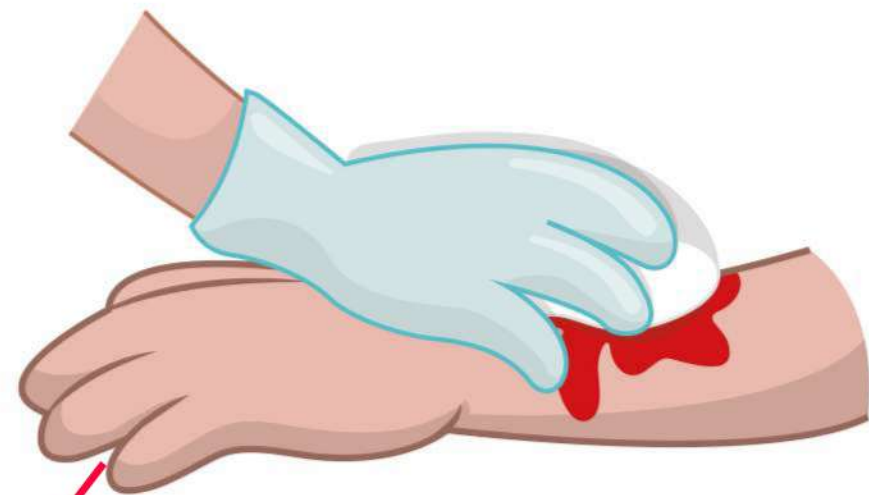

4-8 AÑOS



Centro de Referencia en Primeros Auxilios

REANIMACIÓN CARDIO PULMONAR (RCP)

ACCIDENTE CEREBROVASCULAR

ASFIXIA Y MANIOBRA DE DESOBSTRUCCIÓN

Colorear igual a la imagen en color.

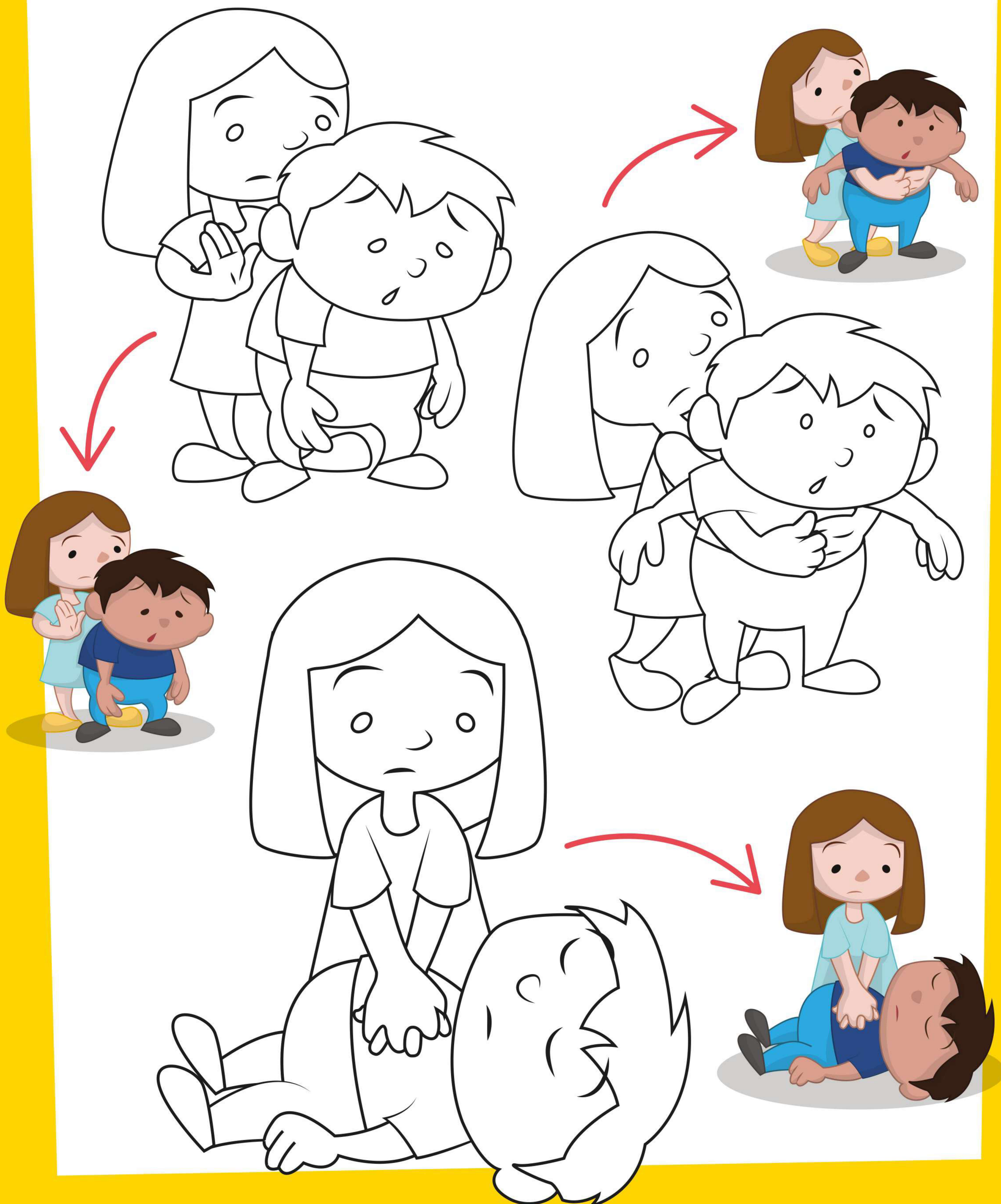

4-8 AÑOS



Centro de Referencia en Primeros Auxilios

INTOXICACIONES

Tachar los productos **tóxicos**.

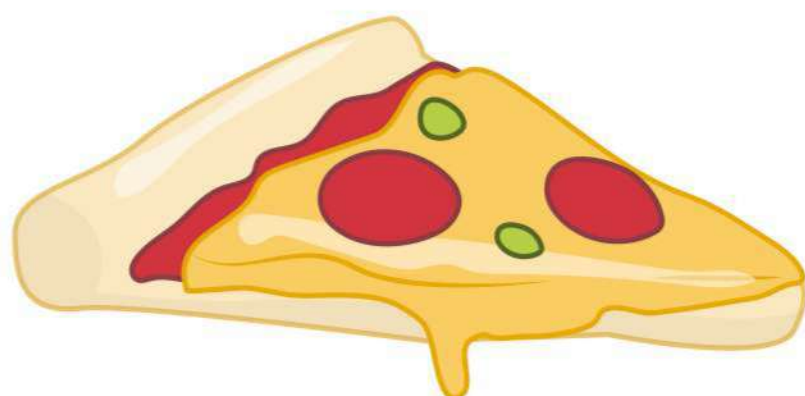
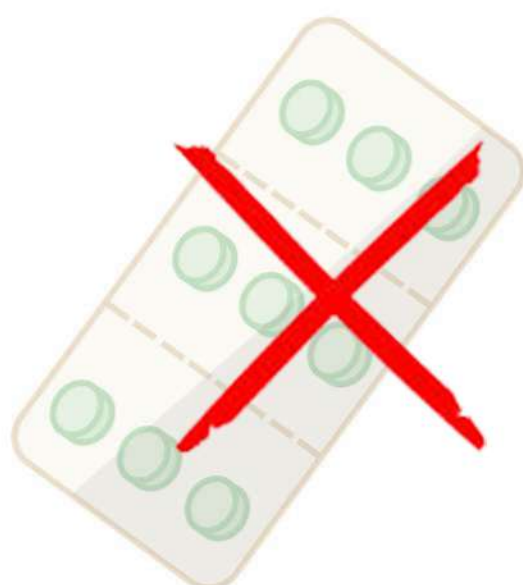

4-8 AÑOS



Centro de
Referencia en
Primeros Auxilios

ALTERACIONES PRODUCIDAS POR FRÍO O CALOR

¿Qué podemos hacer para no sufrir las alteraciones del producidas por **el frío o el calor.** Unir con flechas.

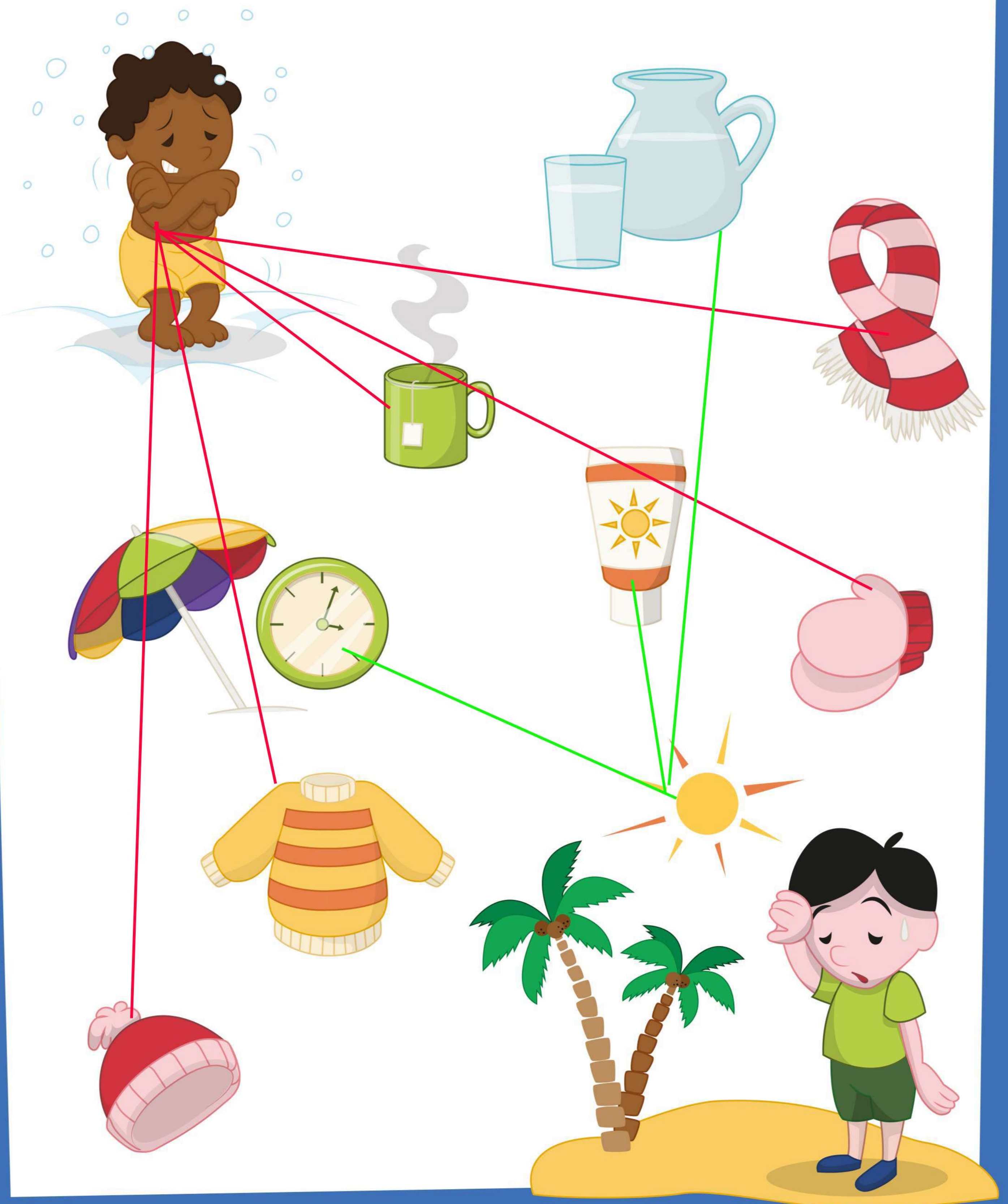

4-8 AÑOS



Centro de Referencia en Primeros Auxilios

PICADURA DE INSECTOS

MORDEDURA DE ANIMALES

Unir con flechas el tipo de **mordedura/picadura** que se corresponde con cada animal/insecto.

